

260W-10014-SFR 400V Traction Set

88 kW drive set for traction applications

Art.-No.: 1843

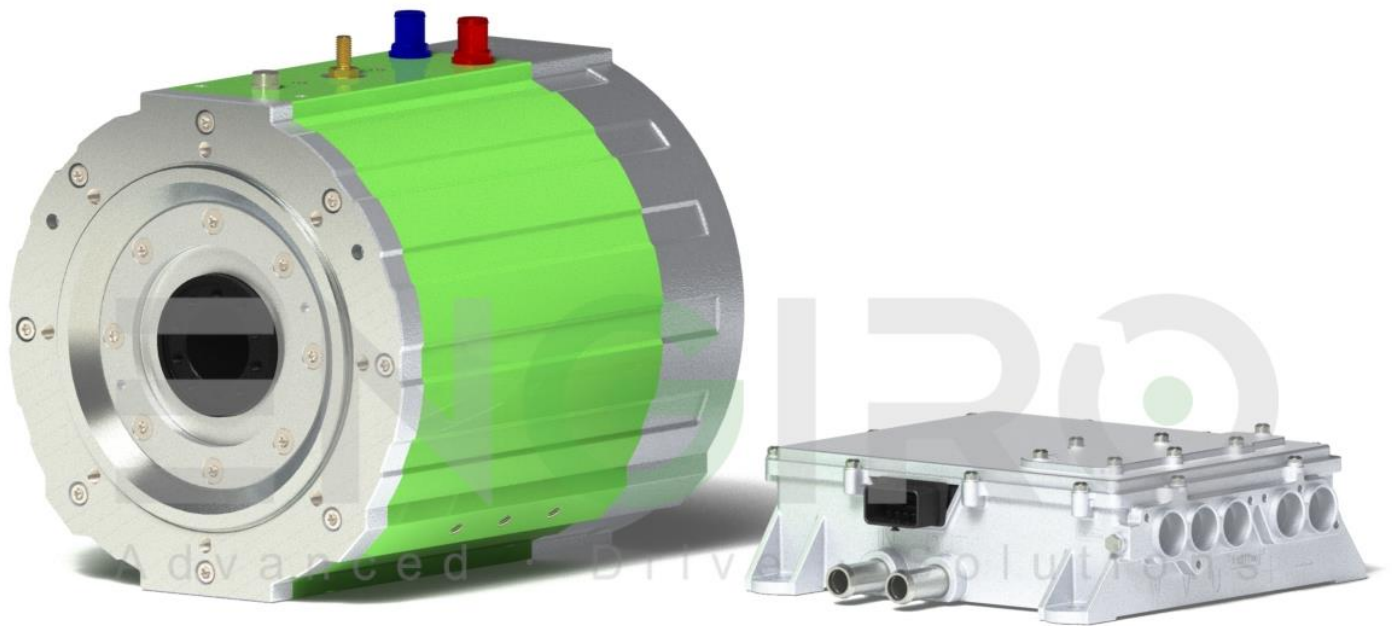

KEY FEATURES

- Interior permanent magnet synchronous machine
- 400V 3-phase motor controller
- Water-cooled
- Double shaft end with screw flange possible
- High efficiency over a wide speed range
- Full torque at zero speed

Section	Page
Operating Range	3
Additional Data	5
Certifications	6
Performance Plots	7
Additional Characteristics	8
Technical Drawings	9
Delivery Content	11

To be noted:

The information in this technical data sheet is based on our current knowledge and experience. Due to the wide range of possible influences during application, they do not exempt the processor and user from carrying out their own tests and trials. Although the suitability for a specific application can be estimated from our information, a legally binding assurance is by no means possible. Depending on the individual case, we recommend consultation with us. Any industrial property rights and applicable laws must be observed by the recipient of our products on his own responsibility.

Data, including specifications, contained within this document are summary in nature and subject to change at any time without notice and are intended for general information only. Call for latest revision. All brand names and product names referenced are trademarks, registered trademarks, or trade names of their respective holders.

Characteristic Operation Points¹⁾ (cooling as specified on next page)

		S1	S2	S2	S2	
Feasible operation time	t_{on}	continuous	30 min	180 sec	30 sec	
Torque	T	233	250	302	410	Nm
Power	P	88	93	106	134	kW
Recuperation power	P_{recu}	93	98	112	149	kW
Phase rms-current (AC)	I_{rms}	240	252	304	450	A
Battery current (DC)	I_{DC}	234	252	283	374	A
Battery voltage (DC)	U_{DC}	400	400	400	400	V
Speed	n	3600	3600	3370	3130	rpm
Electric frequency	f_{el}	300	300	280	261	Hz
Set Efficiency	η_{tot}	94	94	94	90	%

Maximum Operating Range

		Min.	Nom.	Max.	
Torque	T_{max}	-	233	410	Nm
Power	P_{max}	-	88	134	kW
Recuperation power	$P_{max,Recu}$	-	93	149	kW
Phase rms-current	$I_{rms,max}$	-	240	450	A
Battery current (DC)	$I_{DC,max}$	-	234	374	A
Battery voltage (DC)	U_{max}	210	400	450	V
Speed	n_{max}	-	3600	5300	rpm
Electric frequency	$f_{el,max}$	-	300	442	Hz
Power density	$P_{gravimetric}$			1.74	kW/kg

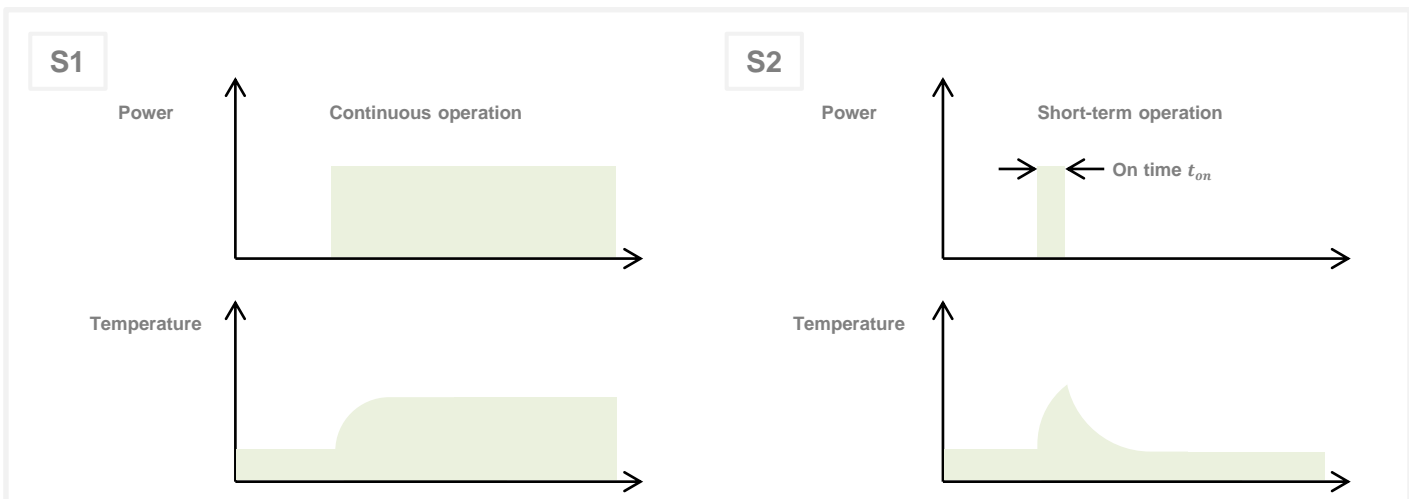

- 1) Defined Range only valid for a power factor of 1 at DC input
- 2) Peak rating for max. 30 seconds on time
- 3) Derating @ 210-250V and >420V
- 4) Higher speeds available upon request. A detailed discussion of the functional safety concept of the vehicle is required.

Data, including specifications, contained within this document are summary in nature and subject to change at any time without notice and are intended for general information only. Call for latest revision. All brand names and product names referenced are trademarks, registered trademarks, or trade names of their respective holders.

S9 operating points
Maximum feasible power in % of S1

$U_{nom} = 96V$		Prior operating point in % of S1				
		0 %	25 %	50 %	75 %	100 %
On time t_{peak}	30 s	150 %	132 %	129 %	127 %	100 %
	80 s	126 %	120 %	118 %	116 %	100 %
	180 s	116 %	113 %	111 %	109 %	100 %

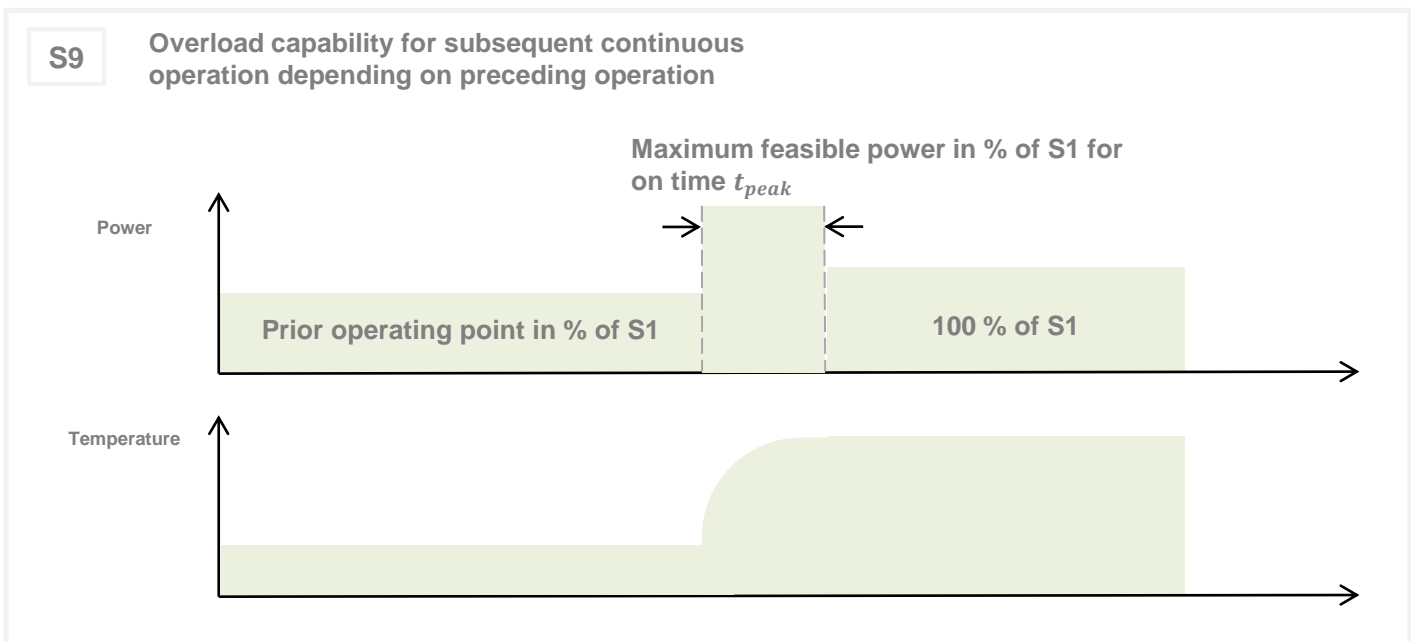

Data, including specifications, contained within this document are summary in nature and subject to change at any time without notice and are intended for general information only. Call for latest revision. All brand names and product names referenced are trademarks, registered trademarks, or trade names of their respective holders.

Additional Data					
		Motor	Inverter ¹⁾		
Weight (w/o cables)		77	8	kg	
Rotor moment of inertia		0.077	-	kg*m ²	
Allowed range of ambient temperature		-20 ... +85	-40 ... +90	°C	
Cooling	Advised medium (OAT Coolants)	water/glycol - 50/50 ▪ TL 774-D/F ▪ VIN 878389 ▪ MAN 324 SNF ▪ MTL 5048			
	Flow rate	> 8	8 – 12	l/min	
	Inlet temperature	≤ 60 ¹⁾	≤ 85	°C	
	Pressure drop	> 0.13, max. 0.5	nom. 0.15	bar	
	Maximum pressure	2	2	bar	
	Cooling channel volume	1.38	0.5	l	
DC link capacitance		-	500	µF	
Temperature monitoring		1 x KTY84-130	Internal		
Rotation direction		freely controllable via CAN-Bus			
Ports					
Power terminals		1 x 2-Phase DC, 1 x 3-Phase AC			
Signal connectors		CMC, 28-Pin			
Cooling connectors		inner Ø 12 mm, outer Ø 19 mm			
Control and Communication					
Type		Slave			
		Speed/Torque control freely controllable via interface			
CAN Bus	Symbol/Baud rate	250/500 kBaud/s			
	Technology	CAN 2.0, J1939 like			
Torque Ramp		Safety limits can be set in inverter by ENGIRO.			
Speed Ramp		Safety limits can be set in inverter by ENGIRO.			

1) Derating for $T_{coolant} > 45^{\circ}\text{C}$

Certifications			
	Motor	Inverter	
Type approval	CE, EN 60034	-	
Environmental	Prepared for ISO 9227	-	
Protection grade	ISO 20653 IP6k9k ²⁾	ISO 20653 IP67	
Vibrations	Prepared for ISO 16750-3	Prepared for ISO 16750-3	
EMC	-	CISPR25 (2016), ECE R10 ¹⁾	
Functional safety	-	Designed for ISO 26262 up to ASIL-C	
Custom tariff number	8501 5350	8504 4088	

- 1) Available upon request.
- 2) Only valid if the machines is installed with suitable cable glands and an appropriate shaft sealing.

Data, including specifications, contained within this document are summary in nature and subject to change at any time without notice and are intended for general information only. Call for latest revision. All brand names and product names referenced are trademarks, registered trademarks, or trade names of their respective holders.

400V

Simulated Motor Characteristics
solid lines: continuous
dashed lines: maximum

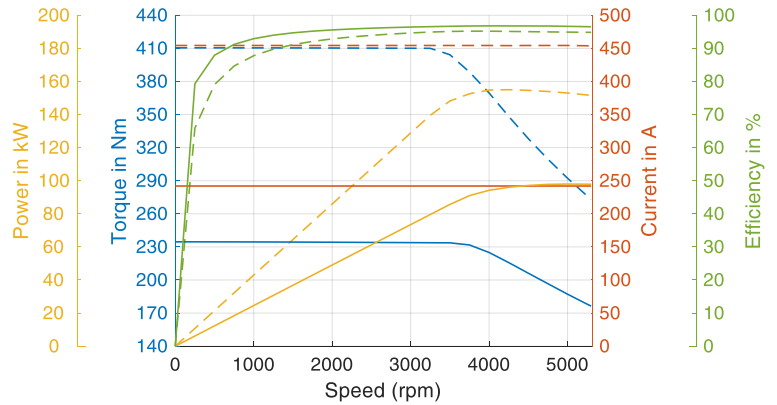

Simulated Generator Characteristics
solid lines: continuous
dashed lines: maximum

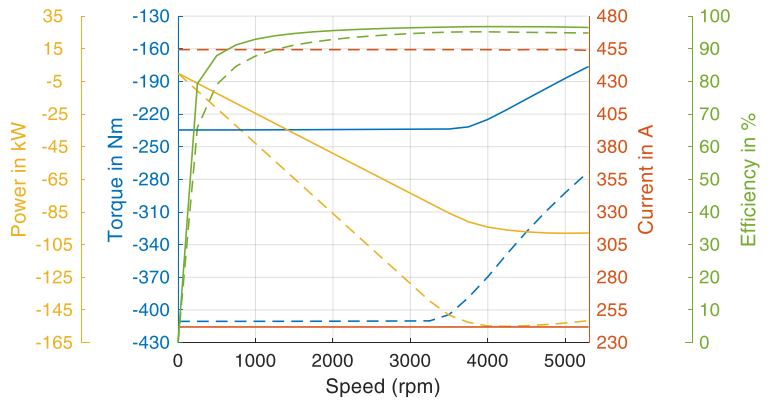

210V

Simulated Motor Characteristics
solid lines: continuous
dashed lines: maximum

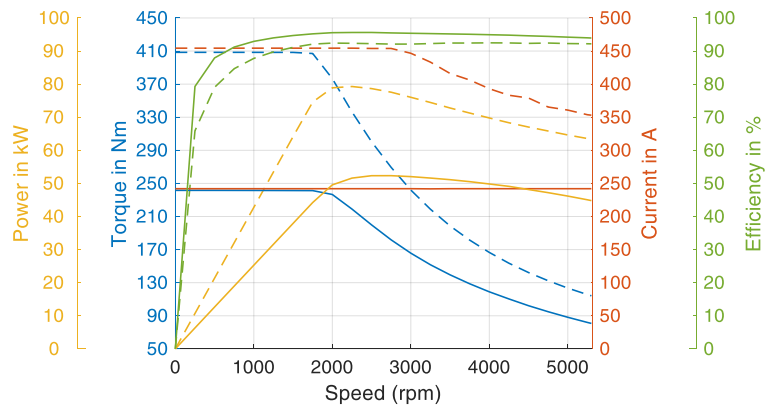

Simulated Generator Characteristics
solid lines: continuous
dashed lines: maximum

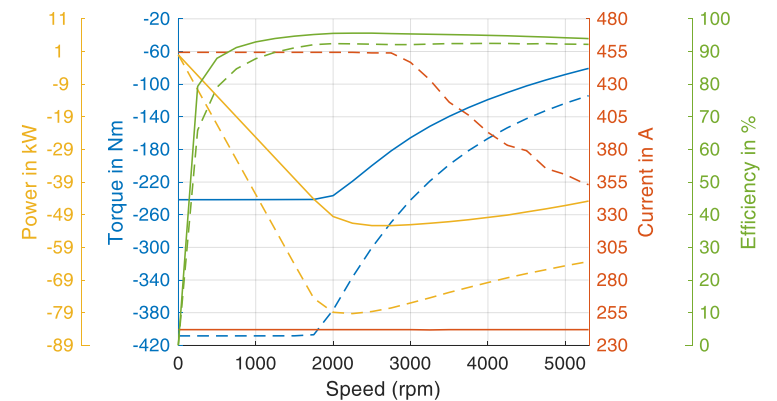

Data, including specifications, contained within this document are summary in nature and subject to change at any time without notice and are intended for general information only. Call for latest revision. All brand names and product names referenced are trademarks, registered trademarks, or trade names of their respective holders.

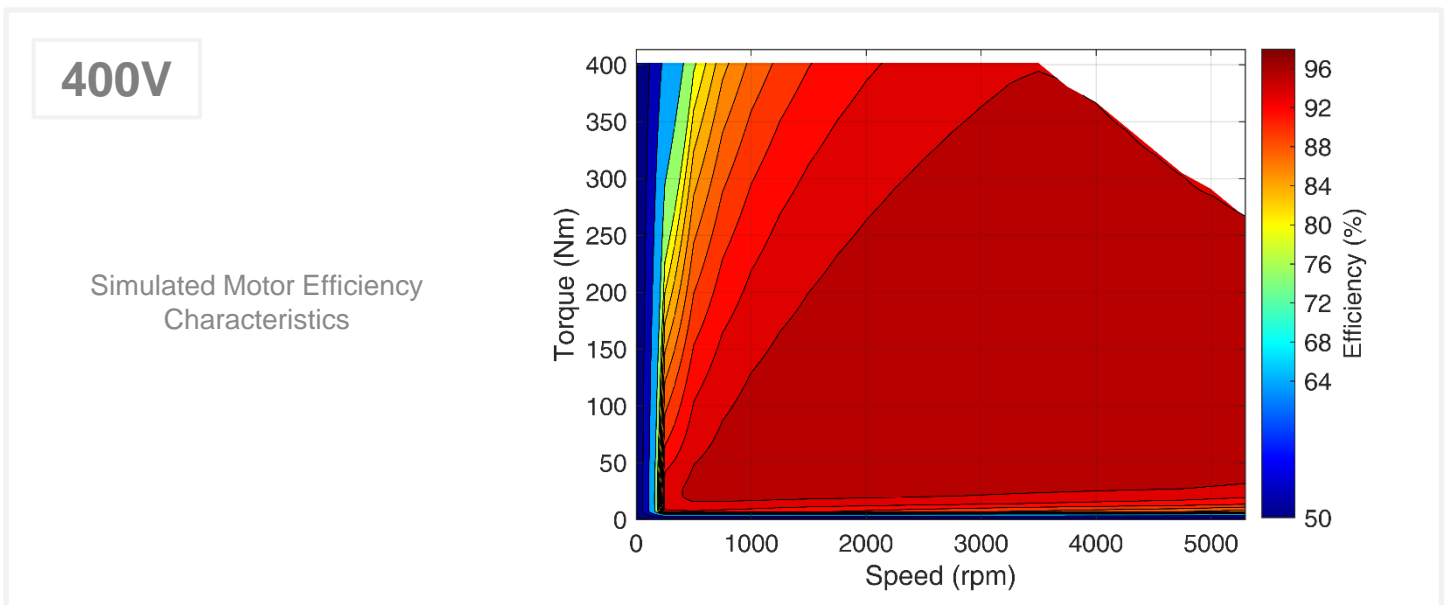
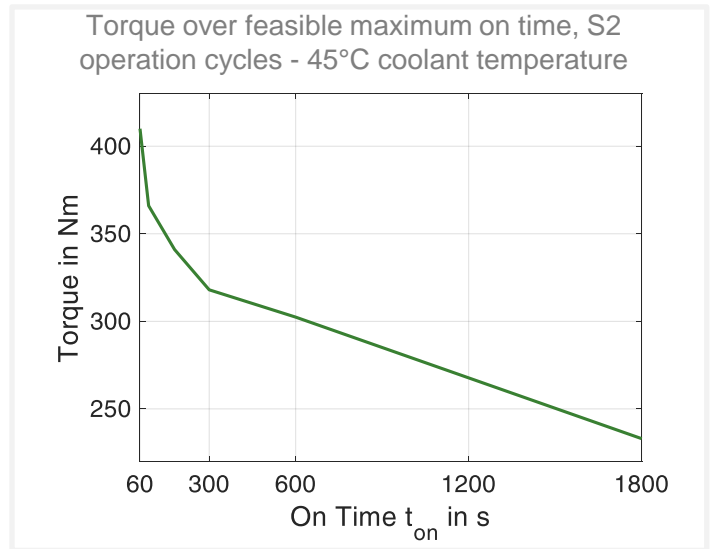
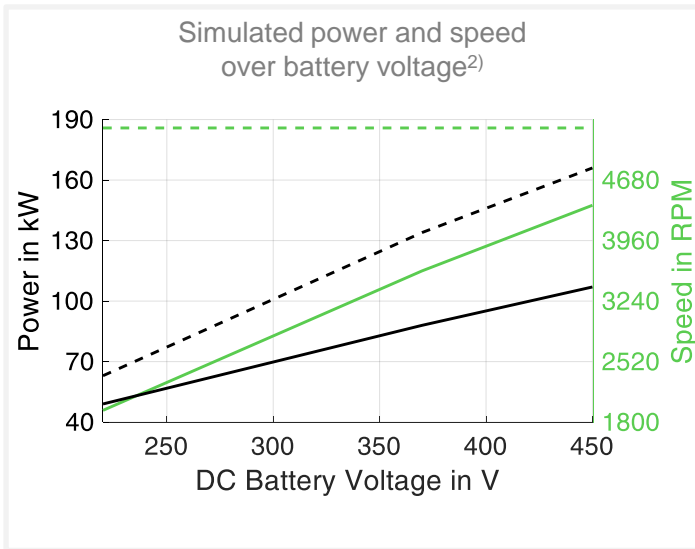
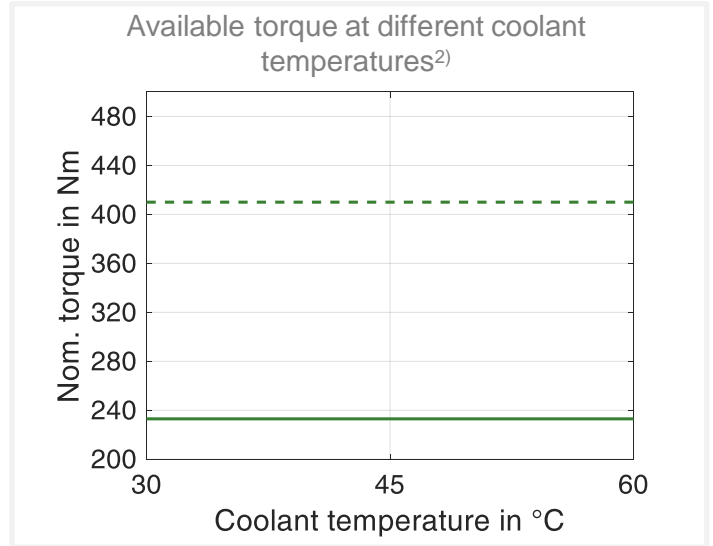
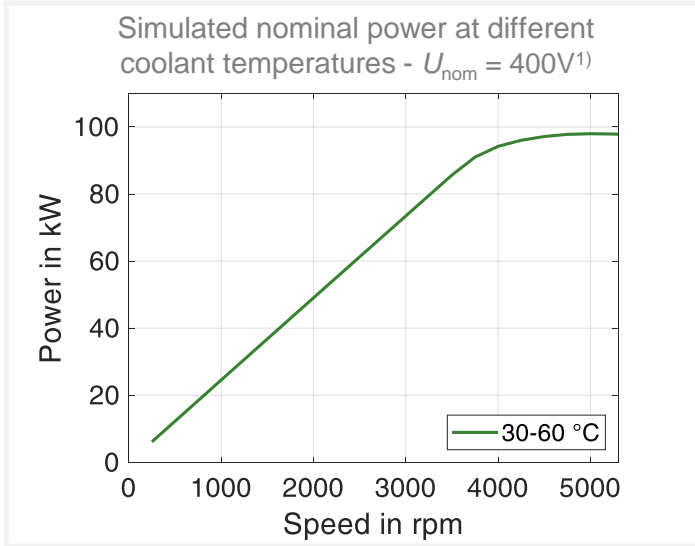

1) Motor current is limited by inverter ratings
2) solid lines: continuous; dashed lines: maximum;

Data, including specifications, contained within this document are summary in nature and subject to change at any time without notice and are intended for general information only. Call for latest revision. All brand names and product names referenced are trademarks, registered trademarks, or trade names of their respective holders.

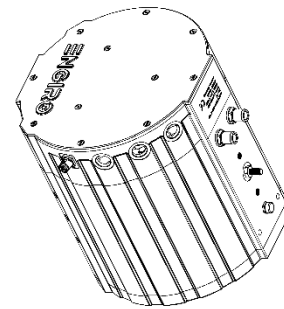
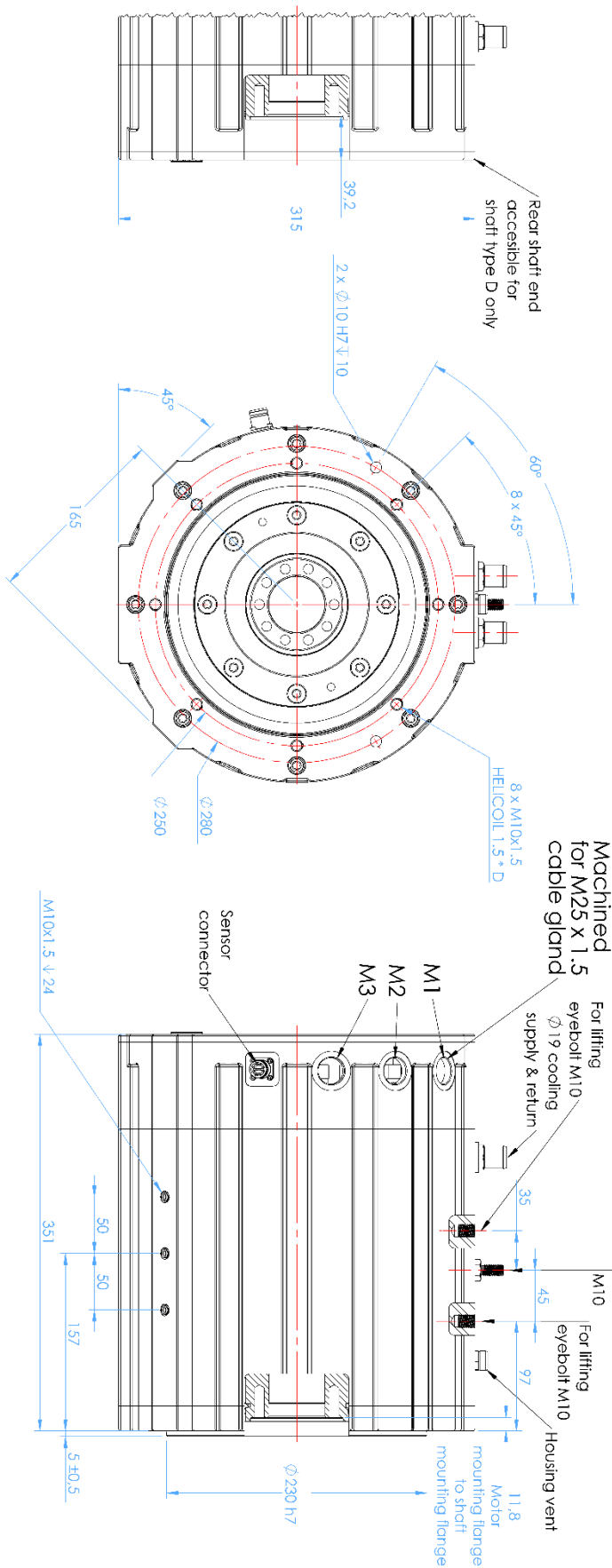

Shaft type S

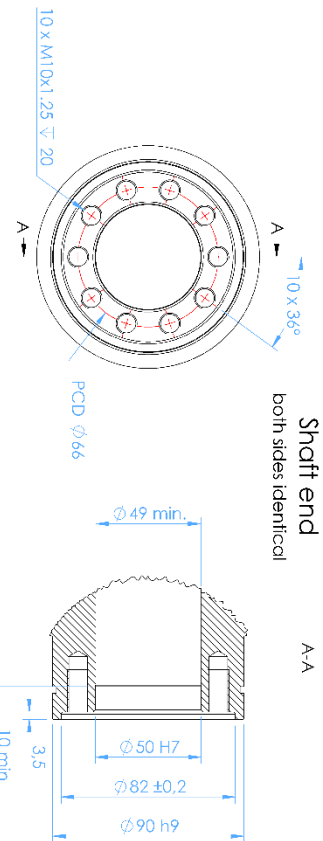

Data, including specifications, contained within this document are summary in nature and subject to change at any time without notice and are intended for general information only. Call for latest revision. All brand names and product names referenced are trademarks, registered trademarks, or trade names of their respective holders.

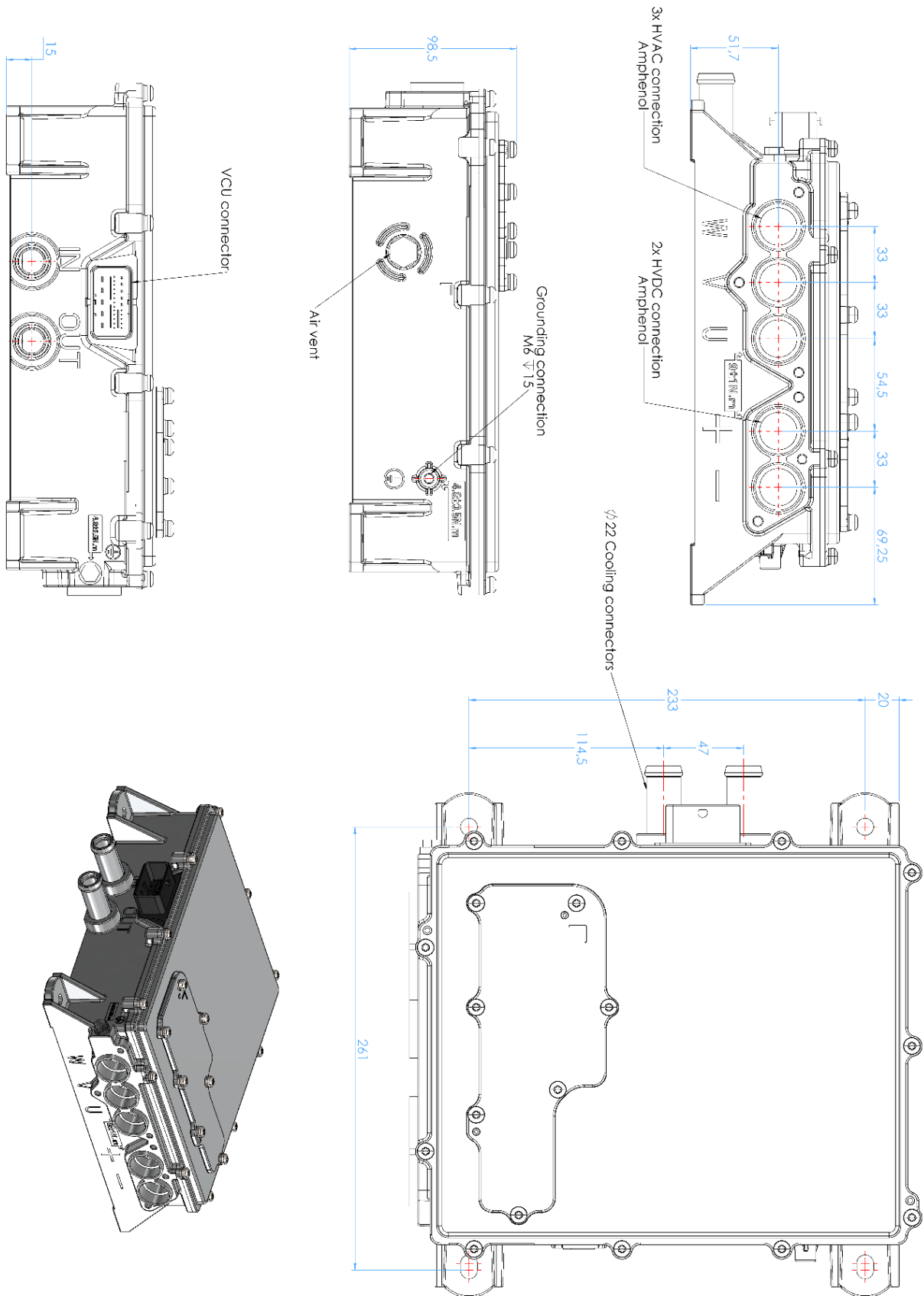

Data, including specifications, contained within this document are summary in nature and subject to change at any time without notice and are intended for general information only. Call for latest revision. All brand names and product names referenced are trademarks, registered trademarks, or trade names of their respective holders.

260W-10014-SFR 400V Set					
Item description				Article number	
Available Motor Variants	A: flange	B: shaft	C: position sensor	Component	Set
	S: single side accessible	F: hollow shaft with two screw flanges	R: resolver	260W_10014_SFR	1843
ENGIRO 400V 3-phase motor controller 240/450A without 400V auxilliary contacts for 260W motor series w/o CAN res.				1586_01	1x
Cables	Amphenol AC port 3 x 50mm ² cables with connector; Length: 2000 mm UVW			1400	1x
	Amphenol DC port 2 x 50mm ² cable with connector; Length: 2000 mm			1414	1x
	Resolver + Temp. data cable for ENGIRO 260W / 3-phase motor controller, length: 2m			1666	1x
Cable glands M25 shielded Pflitsch blueglobe IP 69k				1378	3x
Cable lugs DIN 46234 50-8				1333	3x

included in set

Data, including specifications, contained within this document are summary in nature and subject to change at any time without notice and are intended for general information only. Call for latest revision. All brand names and product names referenced are trademarks, registered trademarks, or trade names of their respective holders.