

260W-20007-ABC

water-cooled motor / generator with 342 kW continuous power

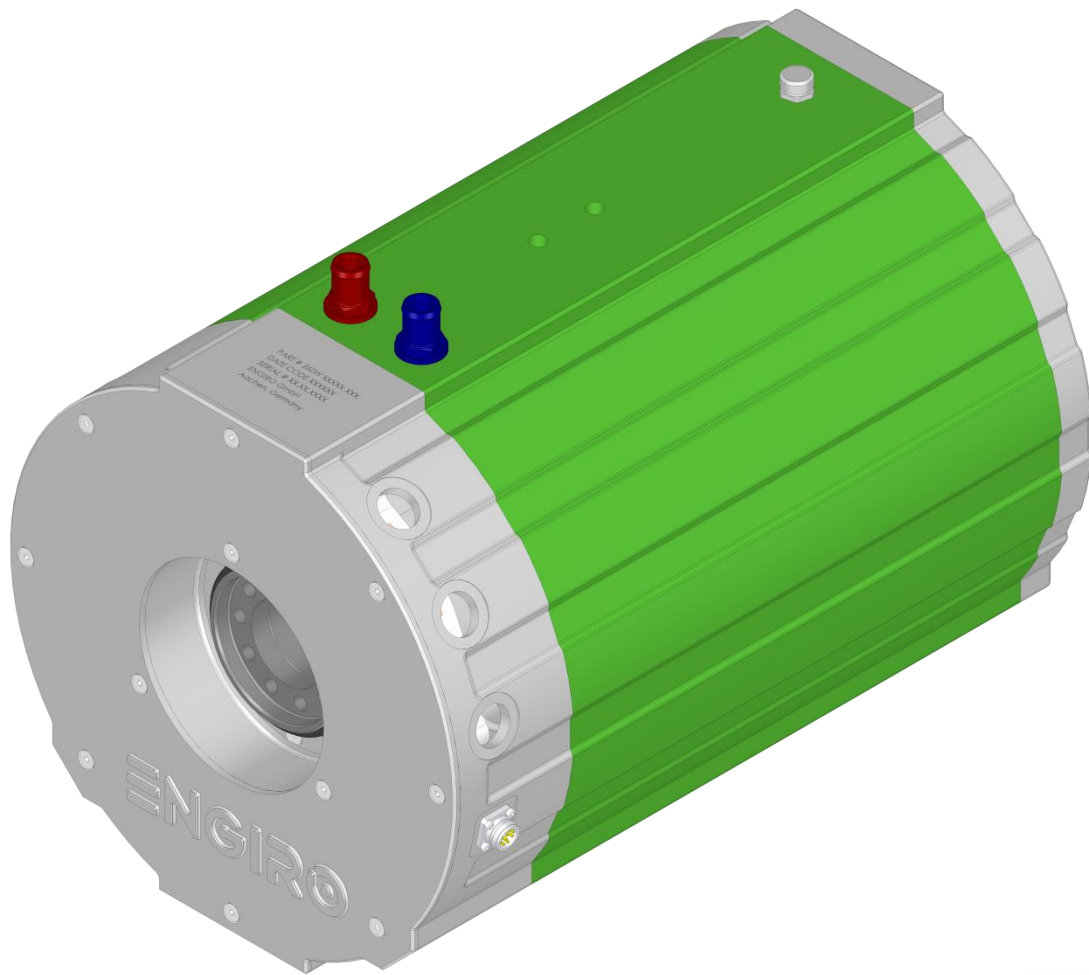

KEY FEATURES

- permanent magnet synchronous machine
- water-cooled
- high peak power for motor applications
- convincing cost-benefit ratio
- recommended voltage range from 500V to 750V
- delivery with controller possible
- Double shaft end with screw flange

Section	Page
Technical Data Machine	3
Technical Drawings Machine	4
Characteristics Machine	5
Technical Data Inverter Set	6

Data, including specifications, contained within this document are summary in nature and subject to change at any time without notice and are intended for general information only. Call for latest revision. All brand names and product names referenced are trademarks, registered trademarks, or trade names of their respective holders.

Nominal Operation (S1, cooling as specified below)				
Torque	T_{nom}		545	Nm
Power	P_{nom}		342	kW
Speed	n_{nom}		6000	rpm
Phase rms-current	I_{nom}		557	A
Battery voltage (DC)	U_{nom}		650	V
Electric frequency	$f_{el,nom}$		500	Hz
Power factor	$\cos(\varphi)$		0.72	
Maximal Values (S2, 10s, cooling as specified below)				
Torque	T_{max}		1093	Nm
Power	P_{max}		672	kW
Phase rms-current	I_{max}		1413	A
Battery voltage (DC)	U_{max}		750	V
Speed	n_{max}		6000	rpm
Electric frequency	$f_{el,max}$		500	Hz
Electrical Data				
Number of phases			3	
Number of pole pairs			5	
Maximal efficiency			>96	%
T/I constant ($I < I_{nom}$)			0.98	Nm/A _{rms}
U/n constant (AC)		rms: 58.8	peak: 83.1	V/(1000rpm)
K_e constant (AC)		rms: 0.112	peak: 0.159	V/(rad*s ⁻¹)
Additional Data				
Weight (w/o cables)			117	kg
Rotor moment of inertia			0.131	kg*m ²
Protection category			IP65 / IP69k	
Maximal motor temperature			140	°C
Allowed ambient temperature			-20 ... 45 ¹⁾	°C
Cooling (medium, flow rate, inlet temperature, pressure)			water/glycol 50/50, 35 l/min, ≤ 45°C, ≤ 0.5 bar	
Temperature monitoring			1 x KTY84-130	
Type approval			CE, EN 60034	
Customs tariff number			8501 5381	
Connectors				
Power terminals			3 x M25 cable gland	
Signal connectors			M16, 10 Pin	
Cooling connectors			2 x 3/4" / 19 mm	

¹⁾ other range on request

Data, including specifications, contained within this document are summary in nature and subject to change at any time without notice and are intended for general information only. Call for latest revision. All brand names and product names referenced are trademarks, registered trademarks, or trade names of their respective holders.

Available Type Variants

type number	A: flange	B: shaft	C: position sensor
260W-20007-	S: standard	F: hollow shaft with two screw flanges	R: resolver
			N: none

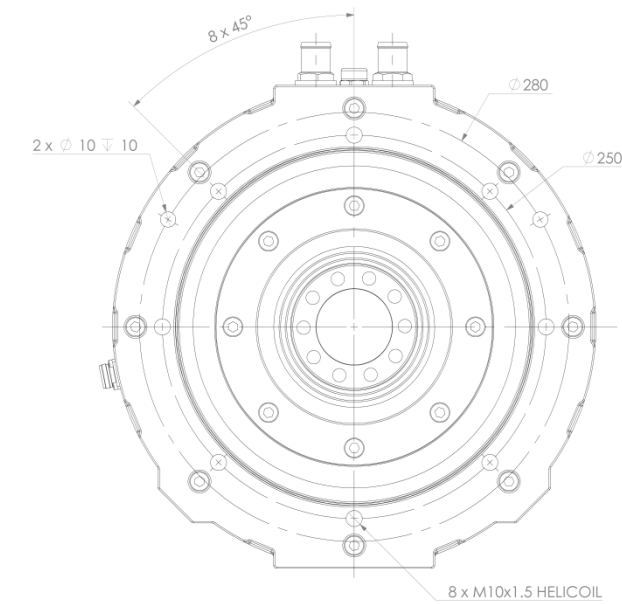

hollow shaft dimensions:

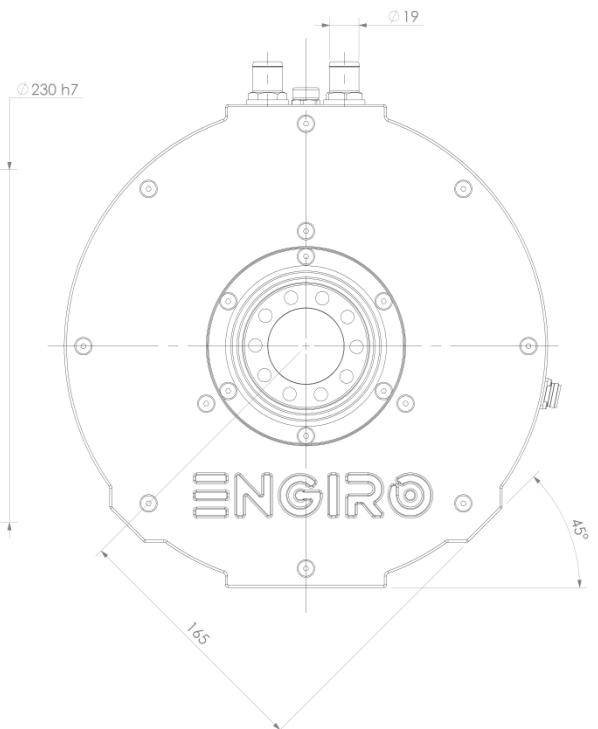
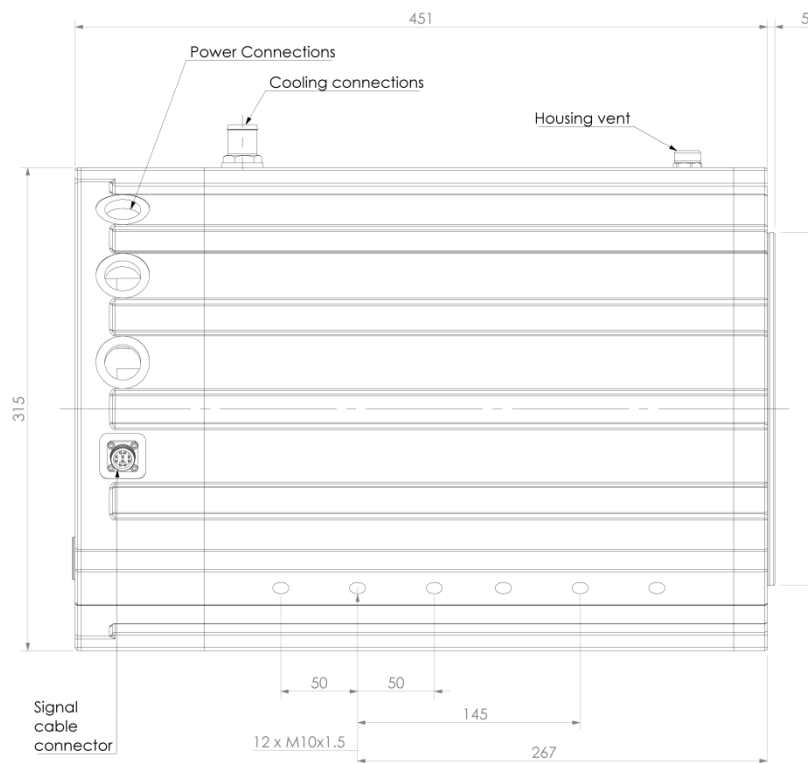
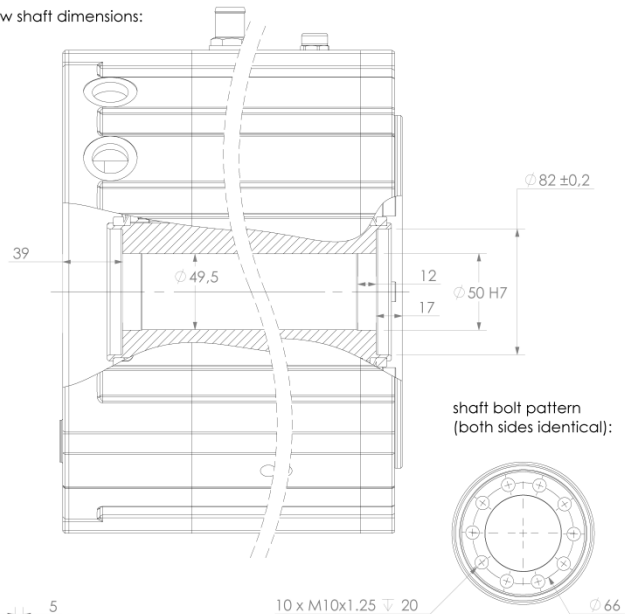

Data, including specifications, contained within this document are summary in nature and subject to change at any time without notice and are intended for general information only. Call for latest revision. All brand names and product names referenced are trademarks, registered trademarks, or trade names of their respective holders.

Simulated Efficiency of Motor Application

(electric machine only; $U_{nom} = 650\text{ V}$; machine at $100\text{ }^\circ\text{C}$;)

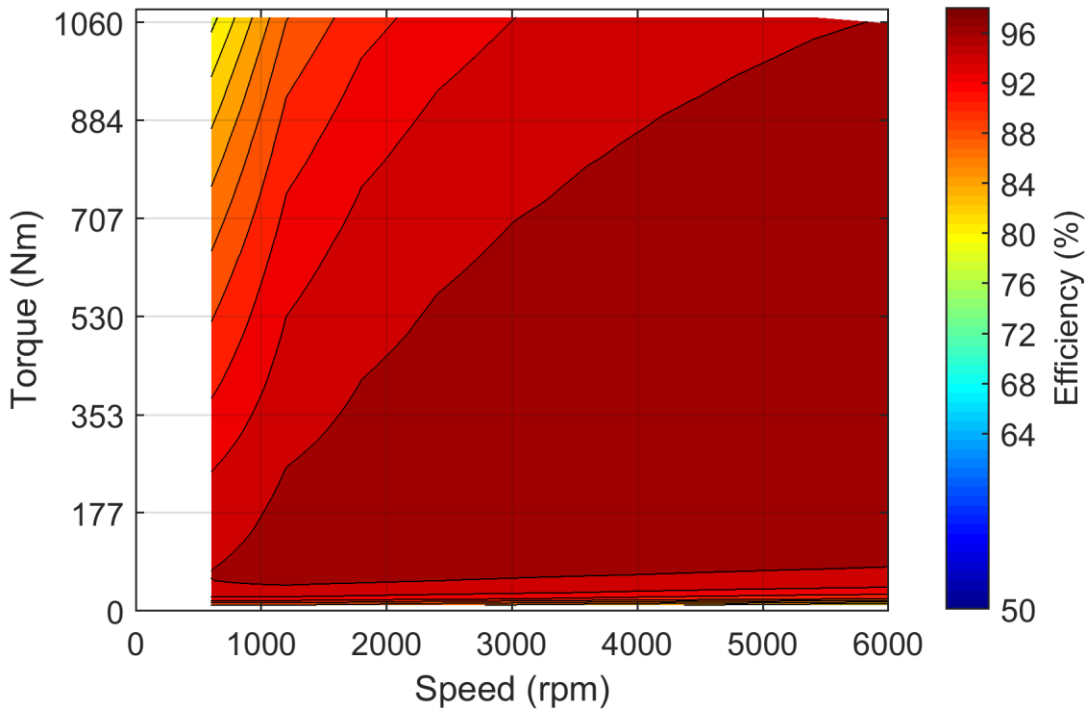

Simulated Characteristic Motor Parameters

$U_{nom} = 650\text{ V}$

solid lines: continuous; dashed lines: maximum;
(jitter is caused by numerical inaccuracies in the simulation software)

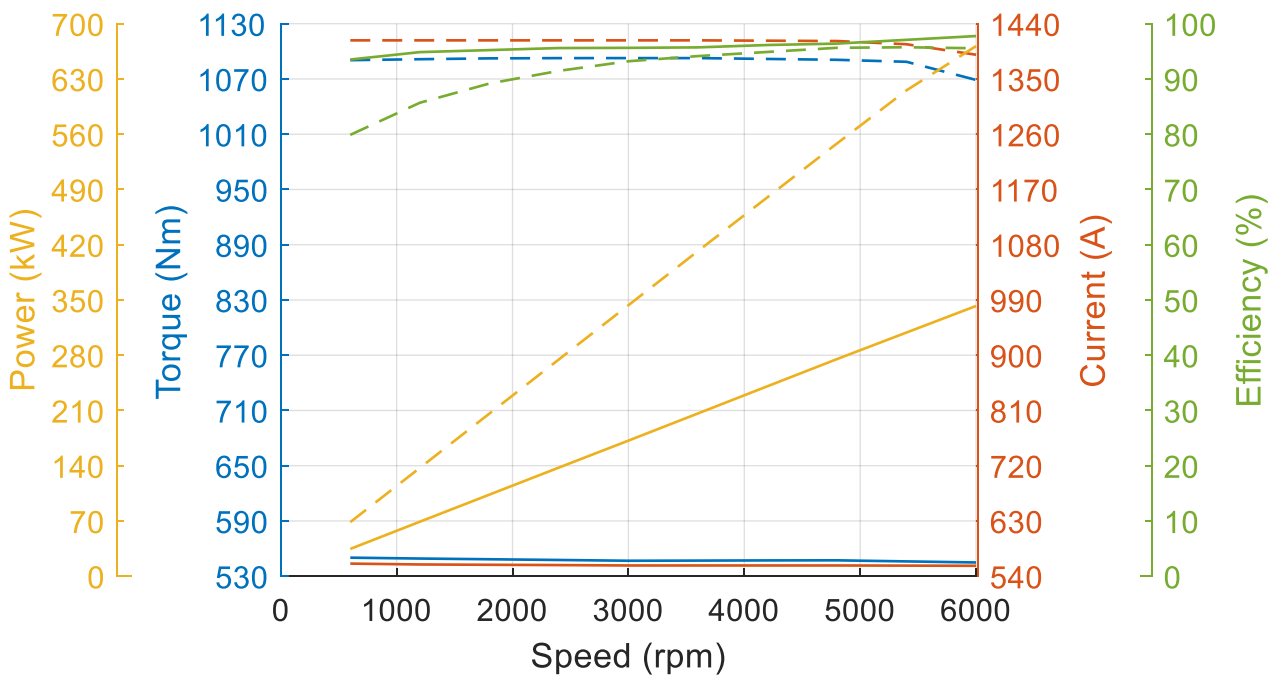

Data, including specifications, contained within this document are summary in nature and subject to change at any time without notice and are intended for general information only. Call for latest revision. All brand names and product names referenced are trademarks, registered trademarks, or trade names of their respective holders.

Nominal Operation Drive Set (S1)			
Torque	T_{nom}	517	Nm
Power	P_{nom}	325	kW
Speed	n_{nom}	6000	rpm
Phase rms-current	I_{nom}	530	A
Battery voltage	U_{nom}	650	V
Electric frequency	$f_{el,nom}$	500	Hz
Power factor	$\cos(\varphi)$	0.72	
Maximal Values Drive Set (S2, 1-10s)			
Torque	T_{max}	577	Nm
Power	P_{max}	361	kW
Phase rms-current	I_{max}	589	A
Battery voltage	U_{max}	650	V
Speed	n_{max}	6000	rpm
Electric frequency	$f_{el,max}$	500	Hz

Simulated Efficiency and Motor Characteristic of Motor Application

(electric machine only; $U_{nom} = 650$ V; machine at 100 °C;)

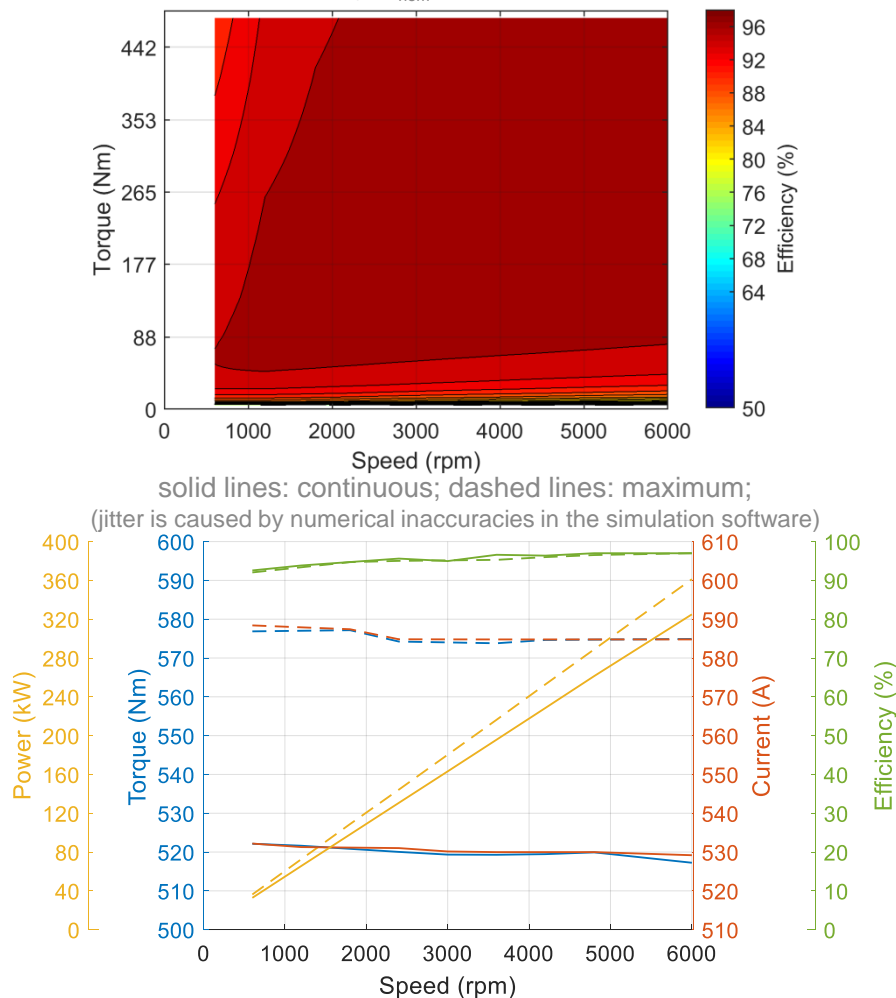

Data, including specifications, contained within this document are summary in nature and subject to change at any time without notice and are intended for general information only. Call for latest revision. All brand names and product names referenced are trademarks, registered trademarks, or trade names of their respective holders.