

205W-16021-ABC

water-cooled motor / generator with up to 31 kW continuous power

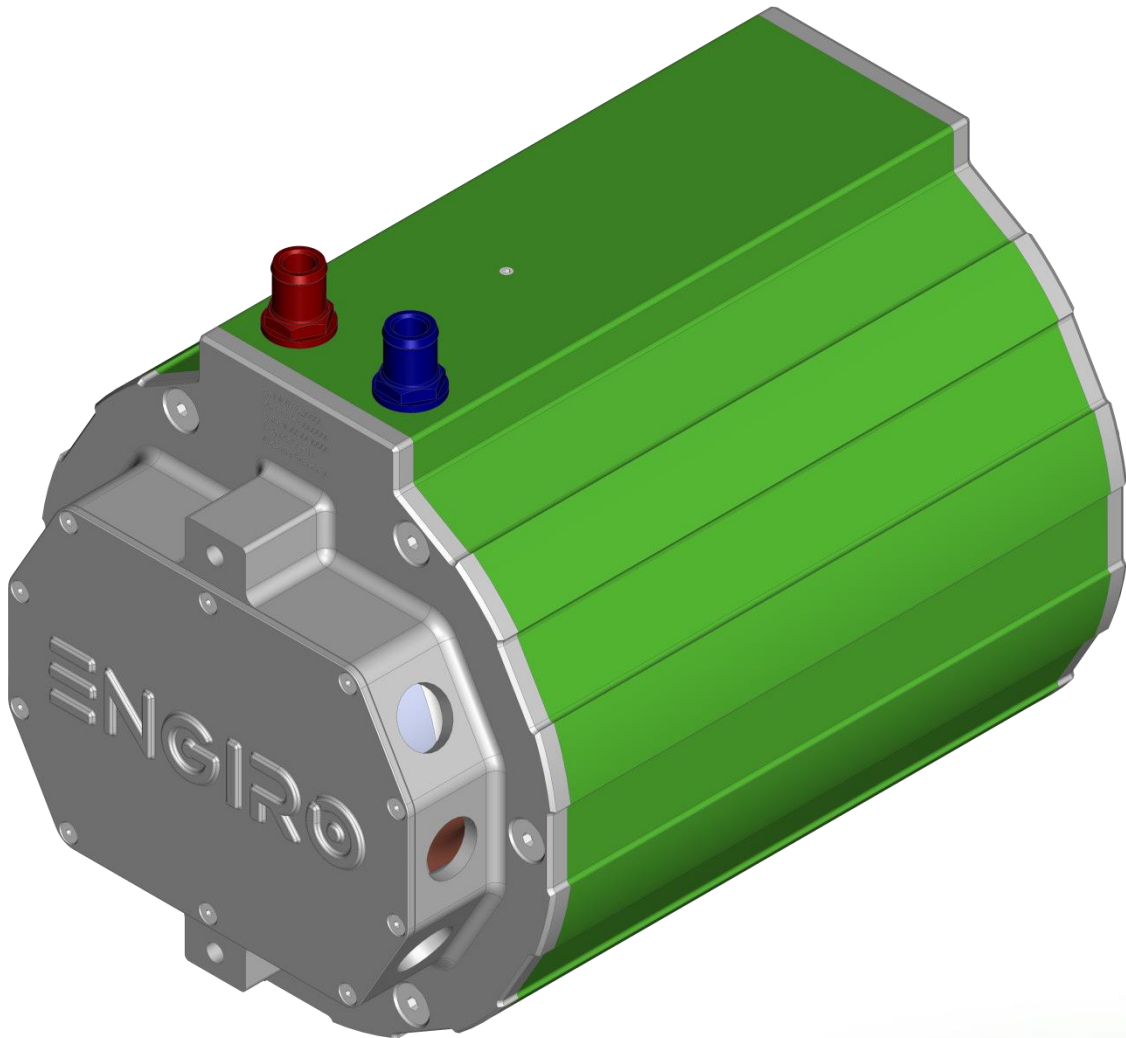

KEY FEATURES

- permanent magnet synchronous machine
- water-cooled
- high peak power for motor applications
- convincing cost-benefit ratio
- recommended voltage range from 48V to 850V
- delivery with controller possible
- various mechanical interfaces available

Section	Page
Technical Data Machine	3
Technical Drawings Machine	4
Characteristics Machine	5

Data, including specifications, contained within this document are summary in nature and subject to change at any time without notice and are intended for general information only. Call for latest revision. All brand names and product names referenced are trademarks, registered trademarks, or trade names of their respective holders.

Nominal Operation (S1, cooling as specified below)				
Torque	T_{nom}		194	Nm
Power	P_{nom}		31	kW
Speed	n_{nom}		1470	rpm
Phase rms-current	I_{nom}		256 ^{1,2)}	A
Battery voltage (DC)	U_{nom}		140	V
Electric frequency	$f_{el,nom}$		98	Hz
Power factor	$\cos(\varphi)$		0.70	
Maximal Values (S2, 10s, cooling as specified below)				
Torque	T_{max}		398	Nm
Power	P_{max}		46	kW
Phase rms-current	I_{max}		594 ²⁾	A
Battery voltage (DC)	U_{max}		850	V
Speed	n_{max}		3860	rpm
Electric frequency	$f_{el,max}$		257	Hz
Electrical Data				
Number of phases			3	
Number of pole pairs			4	
Maximal efficiency			96	%
T/I constant ($I < I_{nom}$)			0.75	Nm/A _{rms}
U/n constant (AC) at a temperature of 30°C	rms:	51.3	peak:	87.2 V/(1000rpm)
K_e constant (AC) at a temperature of 30°C	rms:	0.122	peak:	0.208 V/(rad*s ⁻¹)
Additional Data				
Weight (w/o cables)			see page 4	kg
Rotor moment of inertia			0.0240	kg*m ²
Protection category			IP65 / IP69k	
Maximal motor temperature			140	°C
Allowed ambient temperature			-20 ... 45 ³⁾	°C
Cooling (medium, flow rate, inlet temperature, pressure)			water/glycol 50/50, 12 l/min, ≤ 45°C, ≤ 0.5 bar	
Temperature monitoring			1 x KTY84-130	
Type approval			CE, EN 60034	
Customs tariff number			8501 5230	
Connectors				
Power terminals			3 x M25 cable gland	
Signal connectors			M16, 10 Pin	
Cooling connectors			2 x 3/4" / 19 mm	

¹⁾ Nominal current strongly dependent on cooling as specified below.

²⁾ The cables must not exceed a temperature of 140 °C at any time. Temperature and service life depend on the installation condition.

³⁾ other range on request

Data, including specifications, contained within this document are summary in nature and subject to change at any time without notice and are intended for general information only. Call for latest revision. All brand names and product names referenced are trademarks, registered trademarks, or trade names of their respective holders.

Available Type Variants

type number	A: flange	B: shaft	C: position sensor
205W-16021-	S: standard	S: cylindrical shaft with keyway $\varnothing 28\text{mm}$	R: resolver
			E: sin/cos encoder
			N: none

Approximate machine weight

flange	shaft	kg
S	S	55

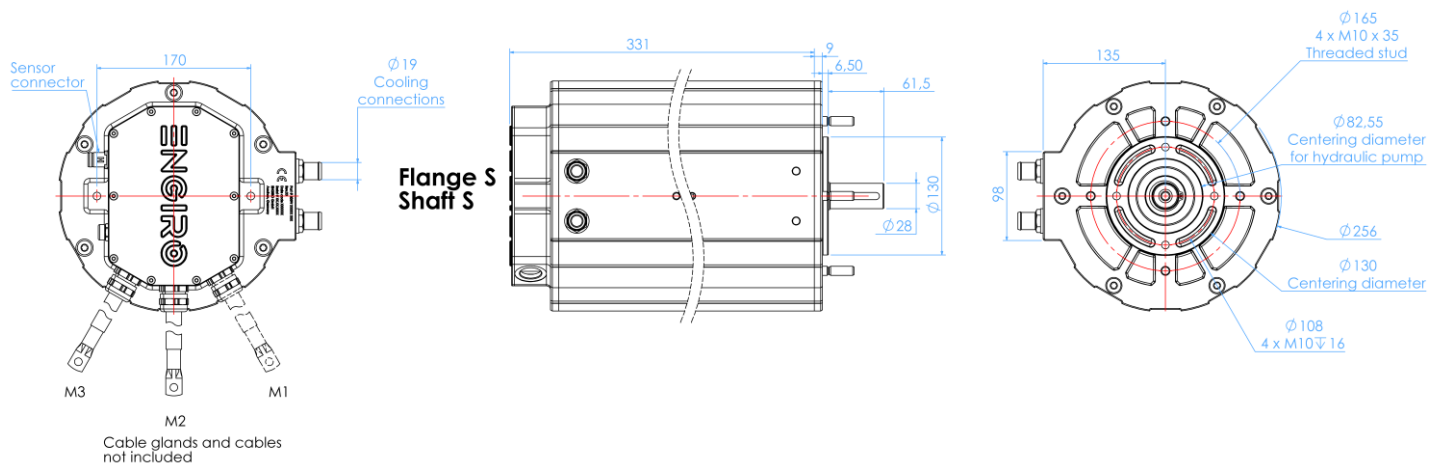

Data, including specifications, contained within this document are summary in nature and subject to change at any time without notice and are intended for general information only. Call for latest revision. All brand names and product names referenced are trademarks, registered trademarks, or trade names of their respective holders.

Simulated Efficiency of Motor Application

(electric machine only; $U_{nom} = 140\text{ V}$; machine at 140 °C ;))

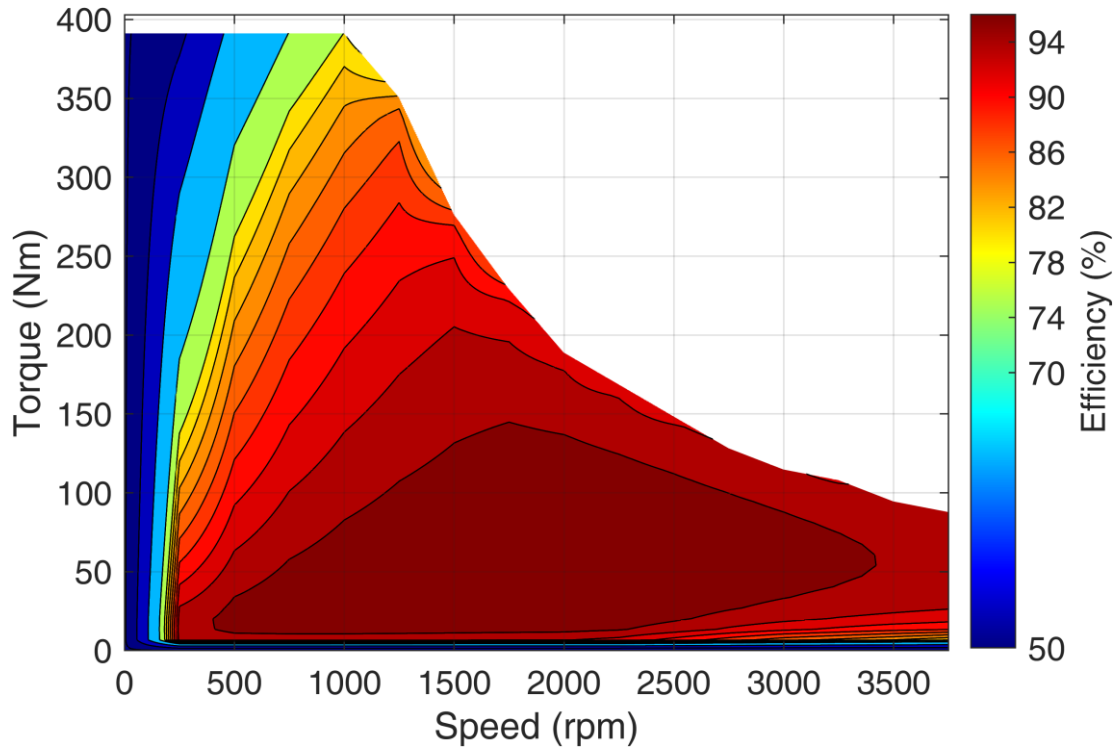

Simulated Characteristic Motor Parameters

$U_{nom} = 140\text{ V}$

solid lines: continuous; dashed lines: maximum;

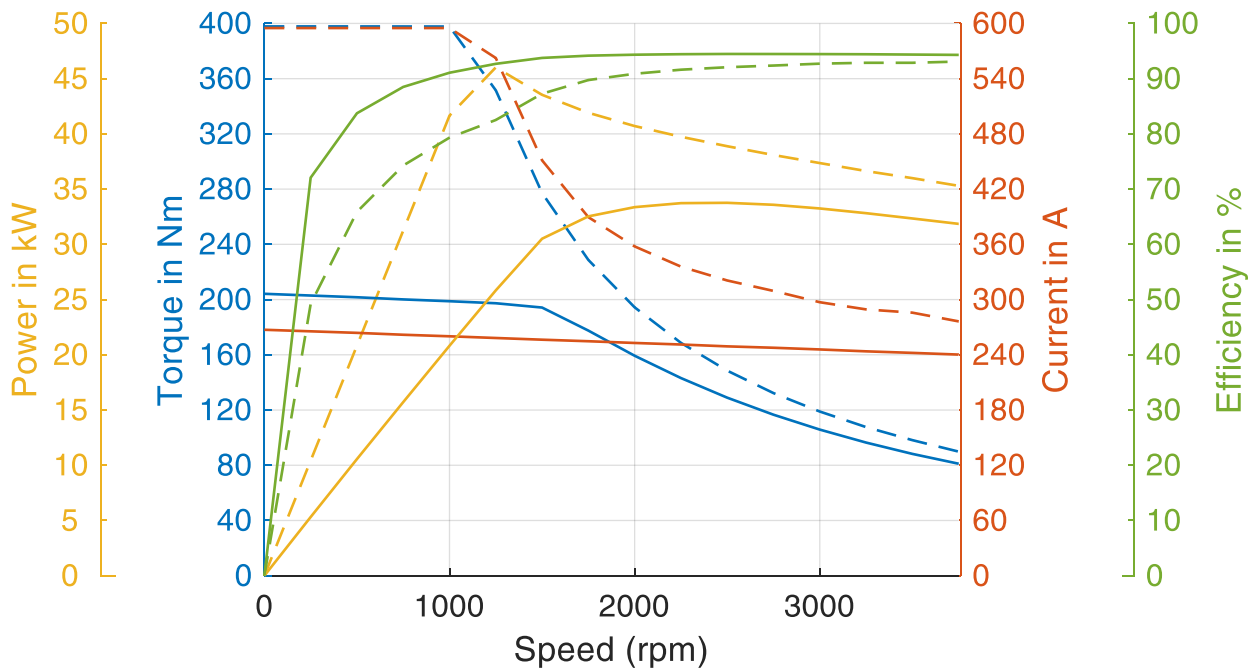

Data, including specifications, contained within this document are summary in nature and subject to change at any time without notice and are intended for general information only. Call for latest revision. All brand names and product names referenced are trademarks, registered trademarks, or trade names of their respective holders.